

120MHz, Ultra-Low Noise Precision Operational Amplifiers

The HA-5147 operational amplifier features an unparalleled combination of precision DC and wideband high speed characteristics. Utilizing the Intersil D. I. technology and advanced processing techniques, this unique design unites low noise (3.2nV/√Hz) precision instrumentation performance with high speed (35V/μs) wideband capability.

This amplifier's impressive list of features include low V_{OS} (30mV), wide gain bandwidth (120MHz), high open loop gain (1500V/mV), and high CMRR (120dB). Additionally, this flexible device operates over a wide supply range (±5V to ±20V) while consuming only 140mW of power.

Using the HA-5147 allows designers to minimize errors while maximizing speed and bandwidth in applications requiring gains greater than ten.

This device is ideally suited for low level transducer signal amplifier circuits. Other applications which can utilize the HA-5147's qualities include instrumentation amplifiers, pulse or RF amplifiers, audio preamplifiers, and signal conditioning circuits.

This device can easily be used as a design enhancement by directly replacing the 725, OP25, OP06, OP07, OP27 and OP37 where gains are greater than ten. For military grade product, refer to the HA-5147/883 data sheet.

Features

- Slew Rate 35V/μs
- Wide Gain Bandwidth (A_V ≥ 10) 120MHz
- Low Noise 3.2nV/√Hz at 1kHz
- Low V_{OS} 30μV
- High CMRR 120dB
- High Gain 1500V/mV
- Pb-Free Available (RoHS Compliant)

Applications

- High Speed Signal Conditioners
- Wide Bandwidth Instrumentation Amplifiers
- Low Level Transducer Amplifiers
- Fast, Low Level Voltage Comparators
- Highest Quality Audio Preamplifiers
- Pulse/RF Amplifiers
- For Further Design Ideas See Application Note AN553

Pinout

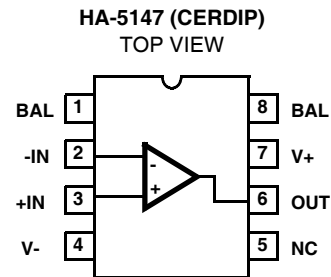

Ordering Information

PART NUMBER	PART MARKING	TEMP. RANGE (°C)	PACKAGE	PKG. DWG. #
HA7-5147-2	HA7- 5147-2	-55 to 125	8 Ld CerDIP	F8.3A
HA7-5147R5254 (Note)	HA7- 5147R5254	-55 to 125	8 Ld CerDIP with Pb-free Hot Solder DIP Lead Finish (SnAgCu)	F8.3A

NOTE: Intersil Pb-free hermetic packaged products employ SnAgCu or Au termination finish, which are RoHS compliant termination finishes and compatible with both SnPb and Pb-free soldering operations. Ceramic dual in-line packaged products (CerDIPs) do contain lead (Pb) in the seal glass and die attach glass materials. However, lead in the glass materials of electronic components are currently exempted per the RoHS directive. Therefore, ceramic dual inline packages with Pb-free termination finish are considered to be RoHS compliant.

HA-5147

Absolute Maximum Ratings $T_A = 25^{\circ}\text{C}$

Voltage Between V+ and V- Terminals 44V
 Differential Input Voltage (Note 1) 0.7V
 Output Current Full Short Circuit Protection

Operating Conditions

Temperature Range
 HA-5147-2 -55°C to 125°C

Thermal Information

Thermal Resistance (Typical, Note 2) θ_{JA} ($^{\circ}\text{C}/\text{W}$) θ_{JC} ($^{\circ}\text{C}/\text{W}$)
 CERDIP Package. 135 50
 Maximum Junction Temperature (Hermetic Package) 175°C
 Maximum Storage Temperature Range -65°C to 150°C
 Maximum Lead Temperature (Soldering 10s) 300°C

CAUTION: Stresses above those listed in "Absolute Maximum Ratings" may cause permanent damage to the device. This is a stress only rating and operation of the device at these or any other conditions above those indicated in the operational sections of this specification is not implied.

NOTES:

1. For differential input voltages greater than 0.7V, the input current must be limited to 25mA to protect the back-to-back input diodes.
2. θ_{JA} is measured with the component mounted on an evaluation PC board in free air.

Electrical Specifications $V_{\text{SUPPLY}} = \pm 15\text{V}$, $C_L \leq 50\text{pF}$, $R_S \leq 100\Omega$

PARAMETER	TEST CONDITIONS	TEMP. ($^{\circ}\text{C}$)	MIN	TYP	MAX	UNITS
INPUT CHARACTERISTICS						
Offset Voltage		25	-	30	100	μV
		Full	-	70	300	μV
Average Offset Voltage Drift		Full	-	0.4	1.8	$\mu\text{V}/^{\circ}\text{C}$
Bias Current		25	-	15	80	nA
		Full	-	35	150	nA
Offset Current		25	-	12	75	nA
		Full	-	30	135	nA
Common Mode Range		Full	± 10.3	± 11.5	-	V
Differential Input Resistance (Note 3)		25	0.8	4	-	$\text{M}\Omega$
Input Noise Voltage (Note 4)	0.1Hz to 10Hz	25	-	0.09	0.25	$\mu\text{V}_{\text{P-P}}$
Input Noise Voltage Density (Note 5)	f = 10Hz	25	-	3.8	8.0	$\text{nV}/\sqrt{\text{Hz}}$
	f = 100Hz		-	3.3	4.5	$\text{nV}/\sqrt{\text{Hz}}$
	f = 1000Hz		-	3.2	3.8	$\text{nV}/\sqrt{\text{Hz}}$
Input Noise Current Density (Note 5)	f = 10Hz	25	-	1.7	-	$\text{pA}/\sqrt{\text{Hz}}$
	f = 100Hz		-	1.0	-	$\text{pA}/\sqrt{\text{Hz}}$
	f = 1000Hz		-	0.4	0.6	$\text{pA}/\sqrt{\text{Hz}}$
TRANSFER CHARACTERISTICS						
Minimum Stable Gain		25	10	-	-	V/V
Large Signal Voltage Gain	$V_{\text{OUT}} = \pm 10\text{V}$, $R_L = 2\text{k}\Omega$	25	700	1500	-	V/mV
		Full	300	800	-	V/mV
Common Mode Rejection Ratio	$V_{\text{CM}} = \pm 10\text{V}$	Full	100	120	-	dB
Gain-Bandwidth-Product	f = 10kHz	25	120	140	-	MHz
	f = 1MHz		-	120	-	MHz

HA-5147

Electrical Specifications $V_{\text{SUPPLY}} = \pm 15\text{V}$, $C_L \leq 50\text{pF}$, $R_S \leq 100\Omega$ (Continued)

PARAMETER	TEST CONDITIONS	TEMP. (°C)	MIN	TYP	MAX	UNITS
OUTPUT CHARACTERISTICS						
Output Voltage Swing	$R_L = 600\Omega$	25	± 10.0	± 11.5	-	V
	$R_L = 2\text{k}\Omega$	Full	± 11.4	± 13.5	-	V
Full Power Bandwidth (Note 6)		25	445	500	-	kHz
Output Resistance	Open Loop	25	-	70	-	Ω
Output Current		25	16.5	25	-	mA
TRANSIENT RESPONSE (Note 7)						
Rise Time		25	-	22	50	ns
Slew Rate	$V_{\text{OUT}} = \pm 3\text{V}$	25	28	35	-	V/ μs
Settling Time	Note 8	25	-	400	-	ns
Overshoot		25	-	20	40	%
POWER SUPPLY CHARACTERISTICS						
Supply Current		25	-	3.5	-	mA
		Full	-	-	4.0	mA
Power Supply Rejection Ratio	$V_S = \pm 4\text{V}$ to $\pm 18\text{V}$	Full	-	16	51	$\mu\text{V/V}$

NOTES:

3. This parameter value is based upon design calculations.
4. Refer to Typical Performance section of the data sheet.
5. The limits for this parameter are guaranteed based on lab characterization, and reflect lot-to-lot variation.
6. Full power bandwidth guaranteed based on slew rate measurement using: $\text{FPBW} = \frac{\text{Slew Rate}}{2\pi V_{\text{PEAK}}}$.
7. Refer to Test Circuits section of the data sheet.
8. Settling time is specified to 0.1% of final value for a 10V output step and $A_V = -10$.

Test Circuits and Waveforms

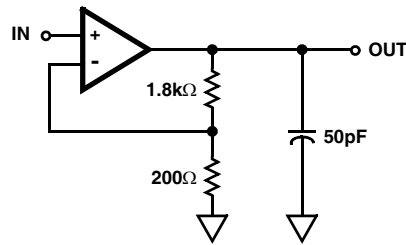
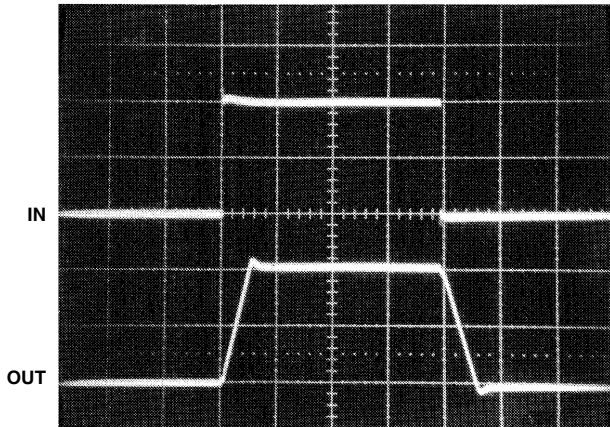
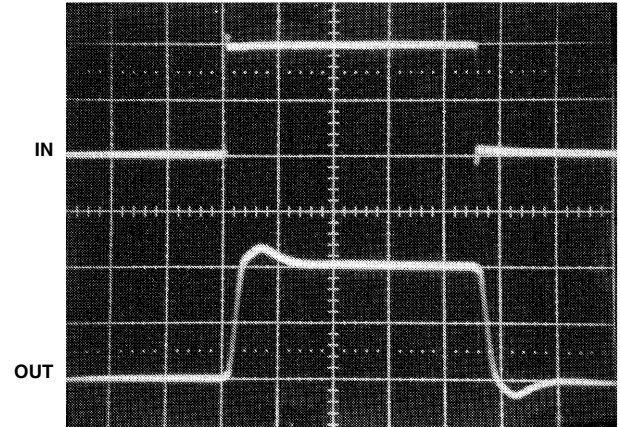

FIGURE 1. LARGE AND SMALL SIGNAL RESPONSE TEST CIRCUIT



Vertical Scale: Input = 0.5V/Div.
 Output = 5V/Div.
 Horizontal Scale: 500ns/Div.

LARGE SIGNAL RESPONSE



Vertical Scale: Input = 10mV/Div.
 Output = 100mV/Div.
 Horizontal Scale: 100ns/Div.

SMALL SIGNAL RESPONSE

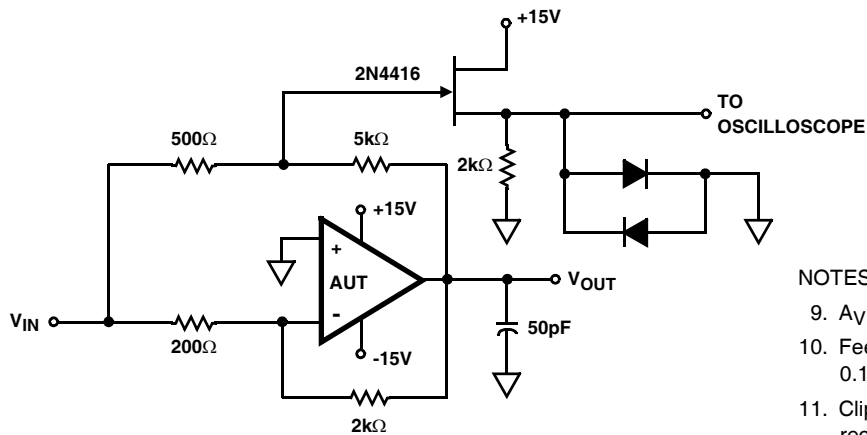

NOTES:

- 9. $A_V = -10$.
- 10. Feedback and summing resistors should be 0.1% matched.
- 11. Clipping diodes are optional. HP5082-2810 recommended.

FIGURE 2. SETTLING TIME TEST CIRCUIT

Schematic Diagram

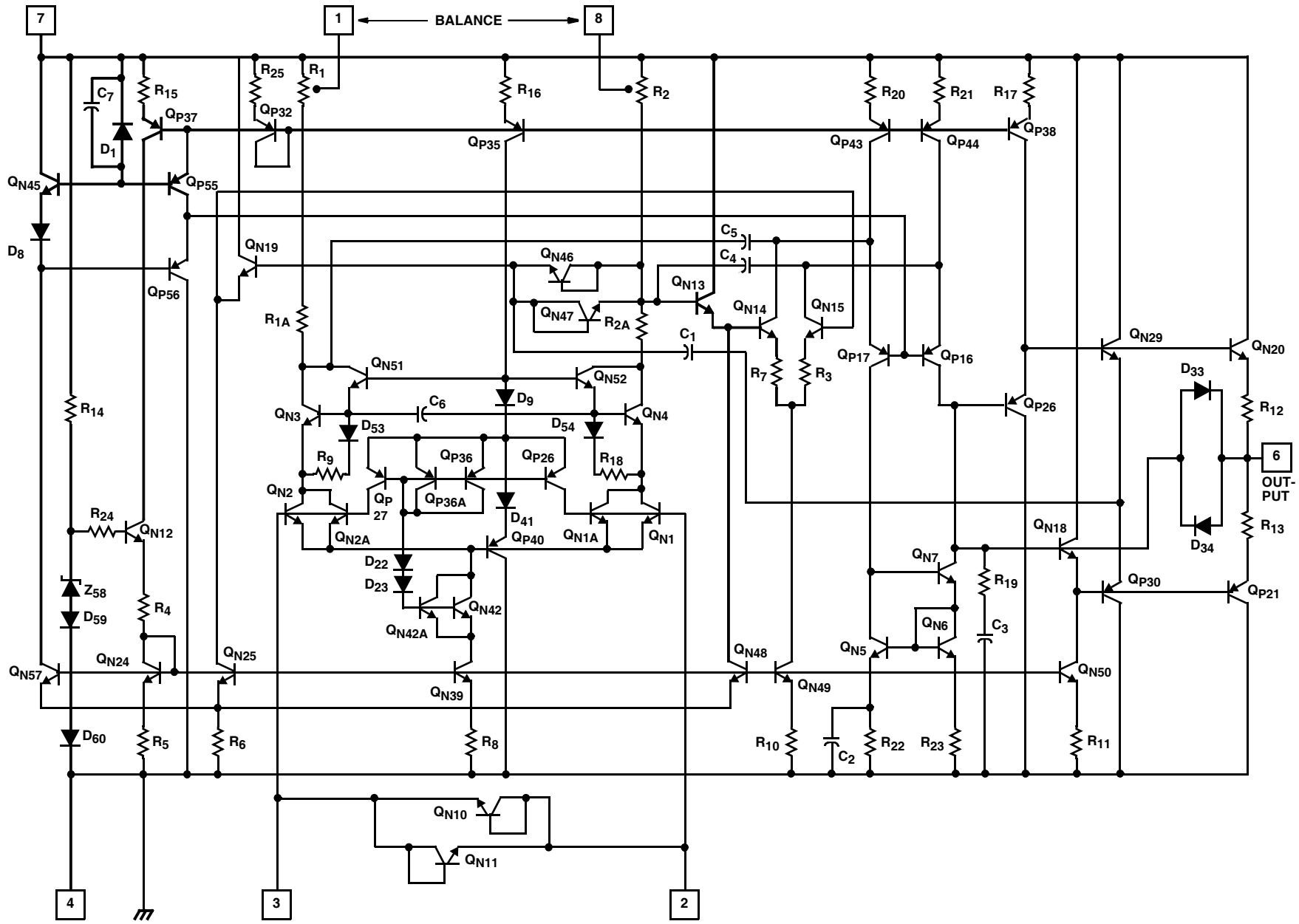

Application Information

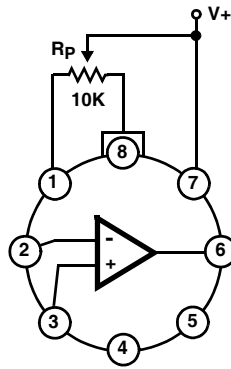

NOTE: Tested Offset Adjustment Range is $|V_{OS} + 1mV|$ minimum referred to output. Typical range is $\pm 4mV$ with $R_p = 10k\Omega$.

FIGURE 3. SUGGESTED OFFSET VOLTAGE ADJUSTMENT

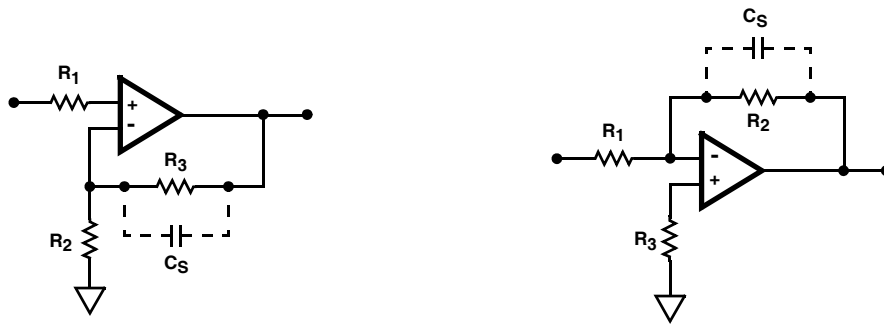

NOTE: Low resistances are preferred for low noise applications as a $1k\Omega$ resistor has $4nV/\sqrt{Hz}$ of thermal noise. Total resistances of greater than $10k\Omega$ on either input can reduce stability. In most high resistance applications, a few picofarads of capacitance across the feedback resistor will improve stability.

FIGURE 4. SUGGESTED STABILITY CIRCUITS

Typical Performance Curves $T_A = 25^\circ C$, $V_{SUPPLY} = \pm 15V$, Unless Otherwise Specified

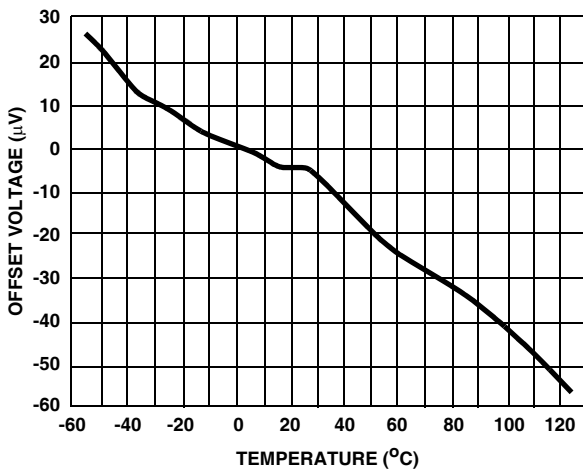

FIGURE 5. TYPICAL OFFSET VOLTAGE vs TEMPERATURE

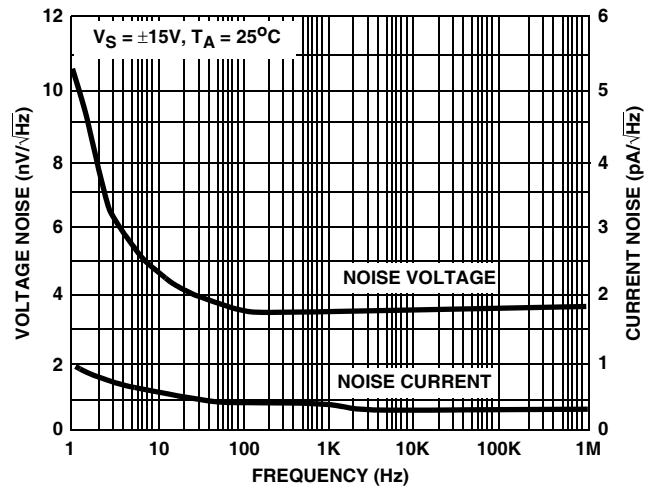

FIGURE 6. NOISE CHARACTERISTICS

Typical Performance Curves $T_A = 25^\circ\text{C}$, $V_{\text{SUPPLY}} = \pm 15\text{V}$, Unless Otherwise Specified (Continued)

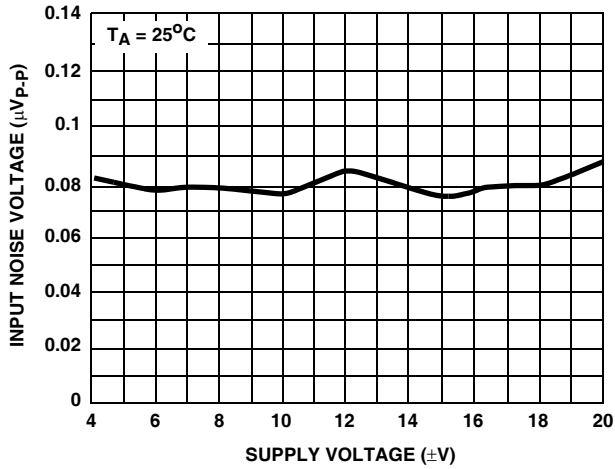

FIGURE 7. NOISE vs SUPPLY VOLTAGE

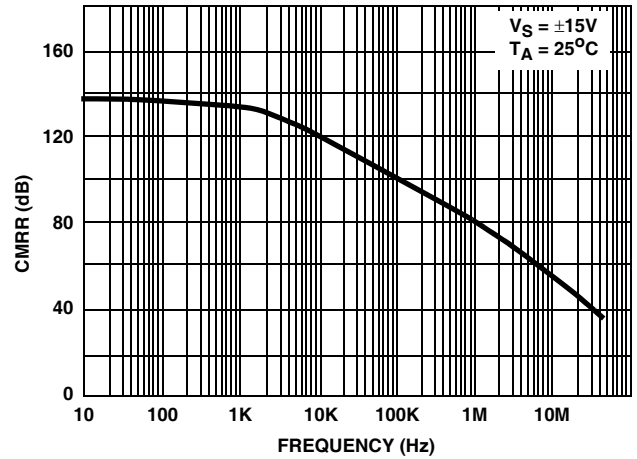

FIGURE 8. CMRR vs FREQUENCY

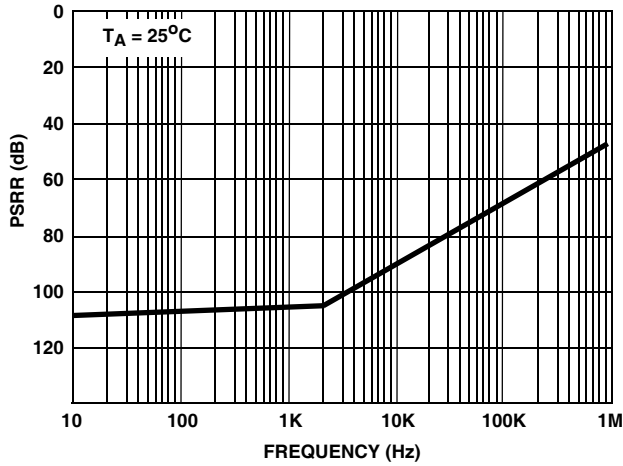

FIGURE 9. PSRR vs FREQUENCY

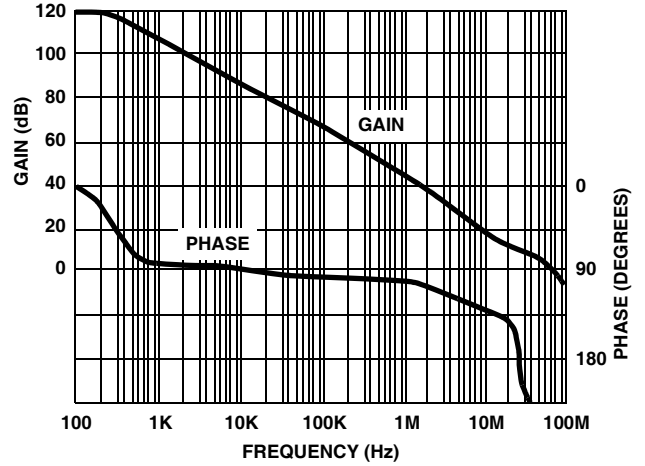

FIGURE 10. OPEN LOOP GAIN AND PHASE vs FREQUENCY

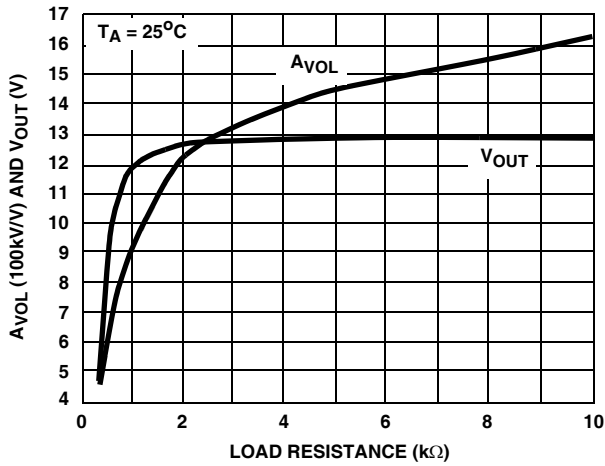

FIGURE 11. A_{VOL} AND V_{OUT} vs LOAD RESISTANCE

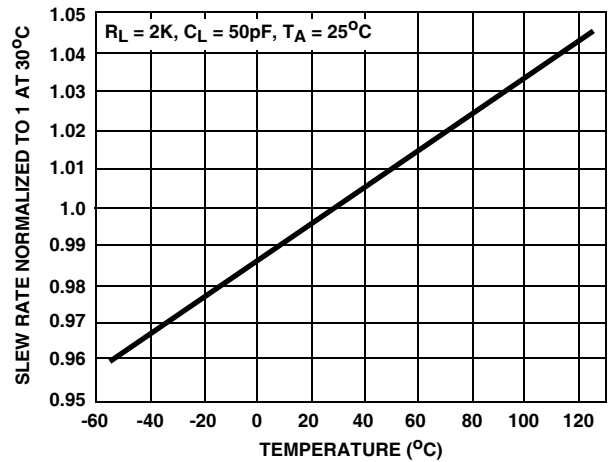

FIGURE 12. NORMALIZED SLEW RATE vs TEMPERATURE

Typical Performance Curves $T_A = 25^\circ\text{C}$, $V_{\text{SUPPLY}} = \pm 15\text{V}$, Unless Otherwise Specified (Continued)

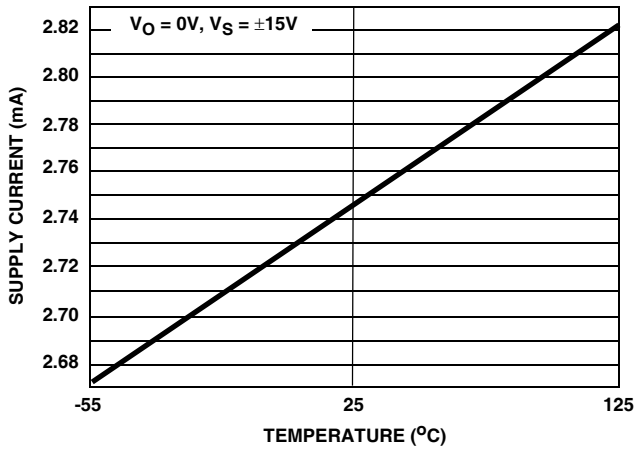

FIGURE 13. SUPPLY CURRENT vs TEMPERATURE

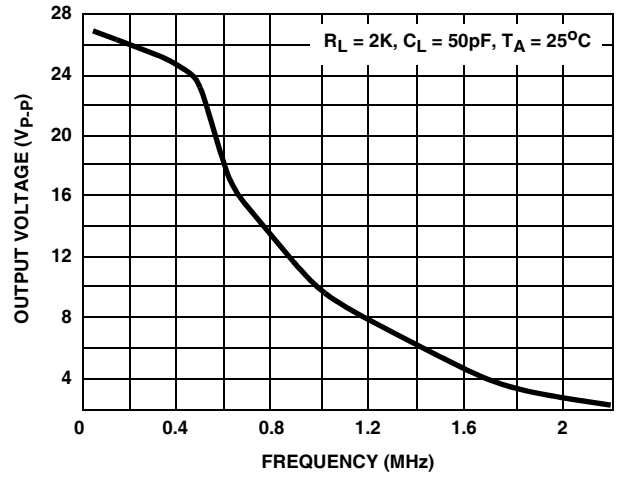

FIGURE 14. $V_{\text{OUT MAX}}$ (UNDISTORTED SINEWAVE OUTPUT) vs FREQUENCY

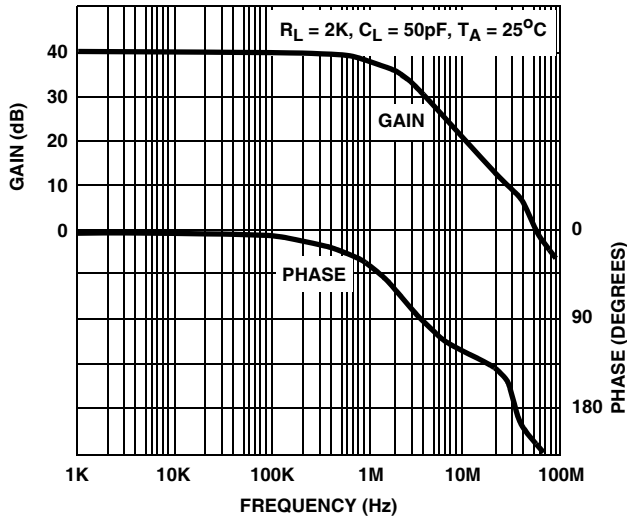
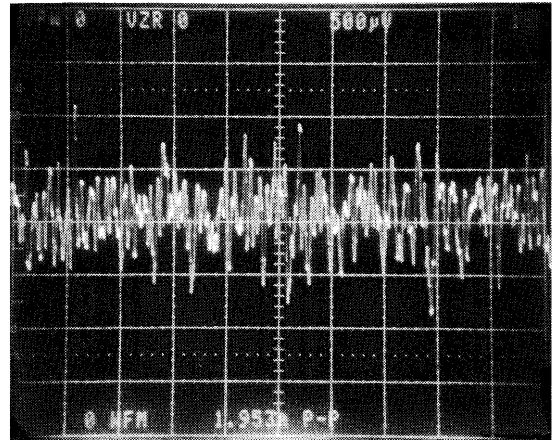

FIGURE 15. CLOSED LOOP GAIN AND PHASE vs FREQUENCY



$A_{\text{CL}} = 25,000\text{V/V}$; $E_{\text{N}} = 0.08\mu\text{Vp-p RTI}$
Horizontal Scale = 1s/Div.; Vertical Scale = 0.002µV/Div.

FIGURE 16. PEAK-TO-PEAK NOISE VOLTAGE (0.1Hz TO 10Hz)

Die Characteristics

DIE DIMENSIONS:

104 mils x 65 mils x 19 mils
2650 μ m x 1650 μ m x 483 μ m

METALLIZATION:

Type: Al, 1% Cu
Thickness: 16k \AA \pm 2k \AA

SUBSTRATE POTENTIAL (POWERED UP):

V-

PASSIVATION:

Type: Nitride (Si_3N_4) over Silox (SiO_2 , 5% Phos.)
Silox Thickness: 12k \AA \pm 2k \AA
Nitride Thickness: 3.5k \AA \pm 1.5k \AA

TRANSISTOR COUNT:

63

PROCESS:

Bipolar Dielectric Isolation

Metallization Mask Layout

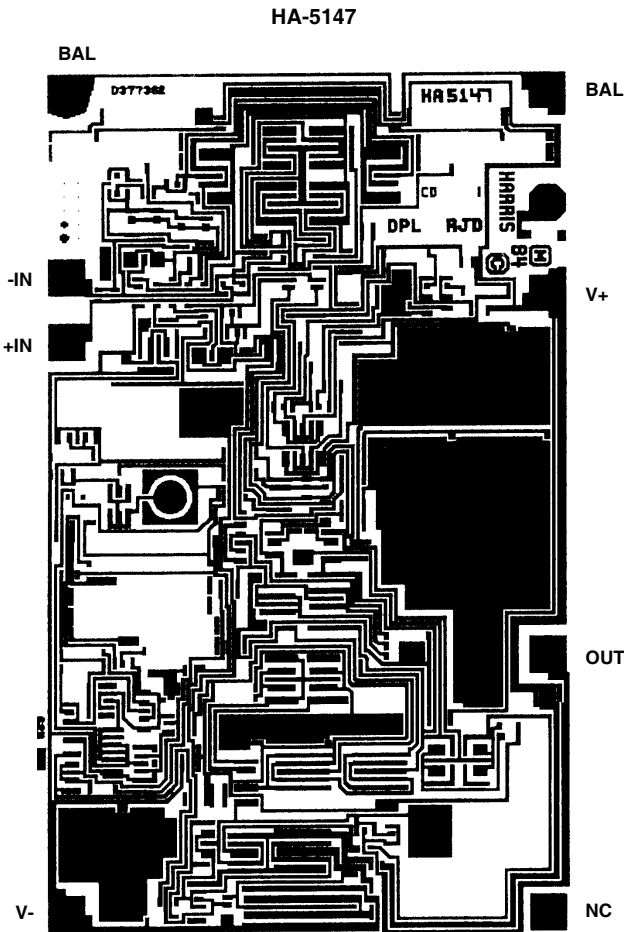

Ceramic Dual-In-Line Frit Seal Packages (CERDIP)

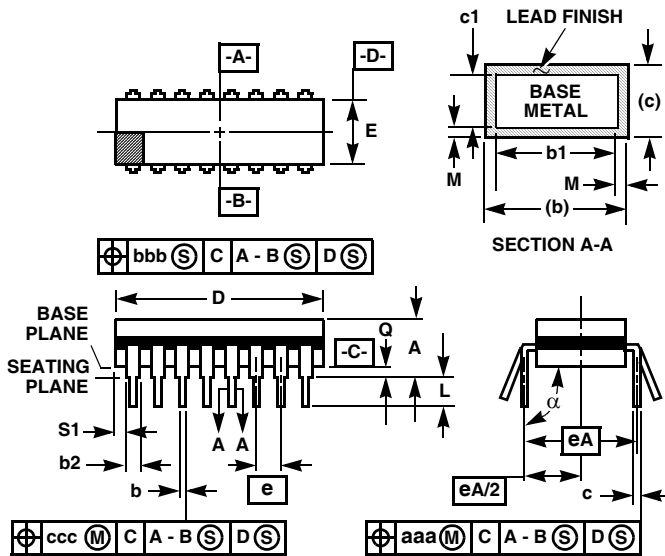

**F8.3A MIL-STD-1835 GDIP1-T8 (D-4, CONFIGURATION A)
8 LEAD CERAMIC DUAL-IN-LINE FRIT SEAL PACKAGE**

SYMBOL	INCHES		MILLIMETERS		NOTES
	MIN	MAX	MIN	MAX	
A	-	0.200	-	5.08	-
b	0.014	0.026	0.36	0.66	2
b1	0.014	0.023	0.36	0.58	3
b2	0.045	0.065	1.14	1.65	-
b3	0.023	0.045	0.58	1.14	4
c	0.008	0.018	0.20	0.46	2
c1	0.008	0.015	0.20	0.38	3
D	-	0.405	-	10.29	5
E	0.220	0.310	5.59	7.87	5
e	0.100 BSC		2.54 BSC		-
eA	0.300 BSC		7.62 BSC		-
eA/2	0.150 BSC		3.81 BSC		-
L	0.125	0.200	3.18	5.08	-
Q	0.015	0.060	0.38	1.52	6
S1	0.005	-	0.13	-	7
alpha	90°	105°	90°	105°	-
aaa	-	0.015	-	0.38	-
bbb	-	0.030	-	0.76	-
ccc	-	0.010	-	0.25	-
M	-	0.0015	-	0.038	2, 3
N	8		8		8

Rev. 0 4/94

NOTES:

1. Index area: A notch or a pin one identification mark shall be located adjacent to pin one and shall be located within the shaded area shown. The manufacturer's identification shall not be used as a pin one identification mark.
2. The maximum limits of lead dimensions b and c or M shall be measured at the centroid of the finished lead surfaces, when solder dip or tin plate lead finish is applied.
3. Dimensions b1 and c1 apply to lead base metal only. Dimension M applies to lead plating and finish thickness.
4. Corner leads (1, N, N/2, and N/2+1) may be configured with a partial lead paddle. For this configuration dimension b3 replaces dimension b2.
5. This dimension allows for off-center lid, meniscus, and glass overrun.
6. Dimension Q shall be measured from the seating plane to the base plane.
7. Measure dimension S1 at all four corners.
8. N is the maximum number of terminal positions.
9. Dimensioning and tolerancing per ANSI Y14.5M - 1982.
10. Controlling dimension: INCH

All Intersil U.S. products are manufactured, assembled and tested utilizing ISO9000 quality systems.
Intersil Corporation's quality certifications can be viewed at www.intersil.com/design/quality

Intersil products are sold by description only. Intersil Corporation reserves the right to make changes in circuit design, software and/or specifications at any time without notice. Accordingly, the reader is cautioned to verify that data sheets are current before placing orders. Information furnished by Intersil is believed to be accurate and reliable. However, no responsibility is assumed by Intersil or its subsidiaries for its use; nor for any infringements of patents or other rights of third parties which may result from its use. No license is granted by implication or otherwise under any patent or patent rights of Intersil or its subsidiaries.

For information regarding Intersil Corporation and its products, see www.intersil.com